



# PARTS CHECKLIST

Be Sure The Part You Need Is The Part You Get



## Empire Style Long Handle Suction Gun Parts

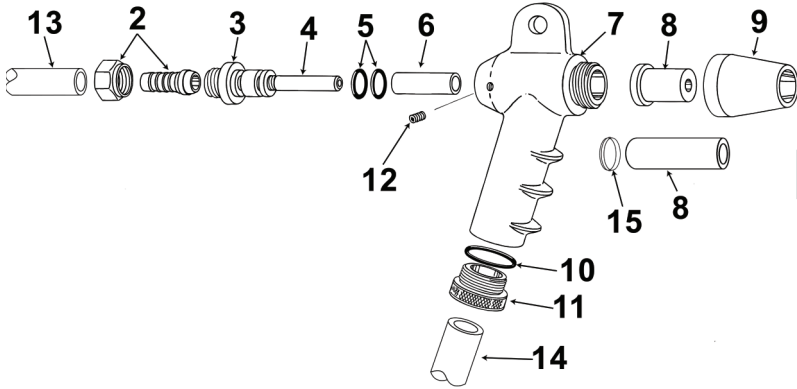

Customer PO #: \_\_\_\_\_  
 Company Name: \_\_\_\_\_  
 Contact Name: \_\_\_\_\_

Proudly Distributed By

*To order parts, fill out this checklist and contact your Forecast Sales, Inc. Distributor*

If you currently do not have a distributor, use the "Distributor Locator" tool on our website to find your 3 closest locations.

Line #		
<input type="checkbox"/>		<b>505-441</b> GUN, LONG HANDLE, 5/16" DICARB NOZZLE, W 5/32" AIR JET
<input type="checkbox"/>		<b>505-451</b> GUN, LONG HANDLE, 7/16" DICARB NOZZLE, W 7/32" AIR JET
<input type="checkbox"/>		<b>505-461</b> GUN, LONG HANDLE, 5/16" BORON NOZZLE, W 5/32" AIR JET
<input type="checkbox"/>		<b>505-466</b> GUN, LONG HANDLE, 3/8" WIDE SPRAY DICARB NOZZLE, W 5/32" AIR JET
<input type="checkbox"/>		<b>505-467</b> GUN, LONG HANDLE, 3/8" WIDE SPRAY DICARB NOZZLE, W 3/16" AIR JET
<input type="checkbox"/>		<b>505-468</b> GUN, LONG HANDLE, 3/8" WIDE SPRAY BORON NOZZLE, W 3/16" AIR JET
<input type="checkbox"/>		<b>505-471</b> GUN, LONG HANDLE, 7/16" BORON NOZZLE, W 7/32" AIR JET
<input type="checkbox"/>		<b>505-481</b> GUN, LONG HANDLE, 5/16" CERAMIC NOZZLE, W 5/32" AIR JET
<input type="checkbox"/>		<b>505-491</b> GUN, LONG HANDLE, 7/16" CERAMIC NOZZLE, W 7/32" AIR JET













Line #		
<input type="checkbox"/>		<b>505-501</b> GUN, LONG HANDLE, 1/4" DICARB NOZZLE, W 1/8" AIR JET
<input type="checkbox"/>		<b>505-511</b> GUN, LONG HANDLE, 1/4" BORON CARBIDE NOZZLE, W 1/8" AIR JET
<input type="checkbox"/>		<b>505-521</b> GUN, LONG HANDLE, 1/4" CERAMIC NOZZLE, W 1/8" AIR JET
<input type="checkbox"/>	<b>2</b>	<b>520-402</b> FITTING, 1/2" HOSE x 1/2", BRASS)
<input type="checkbox"/>	<b>3</b>	<b>505-621</b> CONNECTOR FITTING, LONG & SHORT HANDLE
<input type="checkbox"/>	<b>4</b>	<b>505-651</b> AIR JET, 3/32", (ORANGE)
<input type="checkbox"/>	<b>4</b>	<b>505-661</b> AIR JET, 1/8" (YELLOW)
<input type="checkbox"/>	<b>4</b>	<b>505-671</b> AIR JET, 5/32", (GREEN)
<input type="checkbox"/>	<b>4</b>	<b>505-681</b> AIR JET, 3/16", (BLUE)





# PARTS CHECKLIST

Be Sure The Part You Need Is The Part You Get



Line #		
<input type="checkbox"/>	4	 <b>505-691</b> AIR JET, 7/32", (WHITE)
<input type="checkbox"/>	4	 <b>505-701</b> AIR JET, 1/4", (RED)
<input type="checkbox"/>	5	 <b>523-912</b> O' RING
<input type="checkbox"/>	6	 <b>1450-50</b> RUBBER SLEEVE
<input type="checkbox"/>	7	 <b>753-551</b> GUN BODY, LONG HANDLE
<input type="checkbox"/>	8	 <b>502-421</b> NOZZLE, CERAMIC, STRAIGHT BORE, 1/4" BORE, 1-3/8" LENGTH, FLANGED)
<input type="checkbox"/>	8	 <b>502-431</b> NOZZLE, CERAMIC, STRAIGHT BORE, 5/16" BORE, 1-3/8" LENGTH, FLANGED
<input type="checkbox"/>	8	 <b>502-441</b> NOZZLE, CERAMIC, STRAIGHT BORE, 7/16" BORE, 1-3/8" LENGTH, FLANGED
<input type="checkbox"/>	8	 <b>501-331</b> NOZZLE, TUNGSTEN CARBIDE, STRAIGHT BORE, GUN INSERT, 1/4" BORE, 1-1/8" FLANGE x 1-3/8" LENGTH
<input type="checkbox"/>	8	 <b>501-341</b> NOZZLE, TUNGSTEN CARBIDE, STRAIGHT BORE, GUN INSERT, 5/16" BORE, 1-1/8" FLANGED x 1-3/8" LENGTH
<input type="checkbox"/>	8	 <b>501-351</b> NOZZLE, TUNGSTEN CARBIDE, STRAIGHT BORE, GUN INSERT, 7/16" BORE, 1-1/8" FLANGED x 1-3/8" LENGTH
<input type="checkbox"/>	8	 <b>502-071</b> NOZZLE, BORON CARBIDE, STRAIGHT BORE, GUN INSERT, 1/4" BORE, 1-1/8" FLANGED x 1-3/8" LENGTH

Line #		
<input type="checkbox"/>	8	 <b>502-081</b> NOZZLE, BORON CARBIDE, STRAIGHT BORE, GUN INSERT, 5/16" BORE, 1-1/8" FLANGED x 1-3/8" LENGTH)
<input type="checkbox"/>	8	 <b>502-091</b> NOZZLE, BORON CARBIDE, STRAIGHT BORE, GUN INSERT, 7/16" BORE, 1-1/8" FLANGED x 1-3/8" LENGTH
<input type="checkbox"/>	8	 <b>1348-1820</b> NOZZLE, TUNGSTEN CARBIDE, STRAIGHT BORE, WIDE SPRAY GUN INSERT, 3/8" BORE, 7/8" OD x 2-3/4" LENGTH
<input type="checkbox"/>	8	 <b>1348-600</b> NOZZLE, BORON CARBIDE, STRAIGHT BORE, WIDE SPRAY, GUN INSERT, 3/8" BORE, 7/8" OD x 2-3/4" LENGTH
<input type="checkbox"/>	9	 <b>505-641</b> ADAPTER, NOZZLE (NYLON)
<input type="checkbox"/>	10	 <b>523-881</b> O' RING
<input type="checkbox"/>	11	 <b>520-081</b> NUT, HOSE CLAMP
<input type="checkbox"/>	12	 <b>551-052</b> SET SCREW, 1/4-20 x 3/8" SOCKET, CUP POINT SHORT
<input type="checkbox"/>	13	 <b>112-4580</b> HOSE, AIR, RED, NOMINAL 1/2" ID x 55/64" OD, WP 200 PSI, AIR HOSE COUPLING 2 LUG # UH-050, BOLT CLAMP # BC-012, PRICE PER FOOT, REEL SIZE 500'
<input type="checkbox"/>	14	 <b>520-802</b> HOSE, SUCTION, BLACK, NOMINAL 5/8" ID x 1-1/16" OD, 2 PLY, WP 150 PSI, PRICE PER FOOT, REEL SIZE 400'
<input type="checkbox"/>	15	 <b>1424-480</b> RETAINING RING, WIDE SPRAY